

Load Limiter

Model: LL200

Table of Contents

1- Safety Considerations	3
2- Warranty	4
3- Description	5
4- Principle of operation	6
5- Parameters	6
6- Adjusting the parameters	7
7- Specifications	8
8- Wiring Diagram	9

Safety Considerations

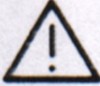
	DANGER
<ul style="list-style-type: none">• HAZARDOUS VOLTAGE can cause serious personal injury or death• This load limiter must be installed and serviced only by qualified electrical personnel in accordance with the National Electric Code (NEC) and any other applicable codes and standards.	

It is important to follow all instructions shipped with this product.

The selection of mounting location for the device, its controls and routing of the wiring is to be accomplished under the direction of the facilities engineer and safety engineer. In addition, listed below are some other important safety instructions and precautions you should follow:

- Read and understand all instructions before installing or operating this equipment.
- After installation, test the load limiter system to ensure that it is operating properly.
- After testing is complete, provide a copy of this instruction sheet to all operating personnel.
- Establish a procedure to routinely check the load limiter installation for integrity and proper operation.

Failure to follow all safety precautions and instruction may result in property damage, serious injury or death.

Warranty

RDA Electronics Co., Ltd. warrants that products of its manufacture shall be free from defects in workmanship or material under normal use or service provided that the load limiter has not been subjected to incorrect voltage, frequency or improper use. For a period of one year from date of shipment, defective equipment will be repaired or replaced, free of charge, when returned F.O.B. factory of the company. The Warranty is lieu of other warranties, expressed or implied, by the Company or its representatives and the said Warranty is also in lieu of legal Warranty or obligations or Warranty imposed by any law. The Company's liability is limited strictly to repair or replacement of the Company's products and no responsibility will be assumed for any consequential damages whatsoever and whether the same be contractual or delictual.

Description

The LL200 is designed to be used in combination with current transformers (CTs), for load limitation of hoisting devices such as electric chain hoists and electric wire rope hoists.

The LL200 can be used on a single speed motor with just one CT required for dual speed motors, both the high speed and low speed can be monitored by the use of two CTs.

The LL200 is used to monitor the working load of a hoisting motor based on the electrical current of motor in low speed and high speed.

The unit supervises the present value of the connected high speed or low speed current. Two limits can be set for the over-current.

The over-current function permits for a certain time period of motor start-up, after that it allows time to crosscheck the instant over-current before it gives a signal through its relay. With exceed of the pre-set value a time cycle will be started. If the condition of exceeding remains present after the end of the time cycle the output relay will be switched.

Times and currents will be set digitally and stored in memory, the setting is simplified and no require measuring instruments. Motor current is displayed on the screen during operation. Wiring simplified by using pre-wired cable and exterior CTs.

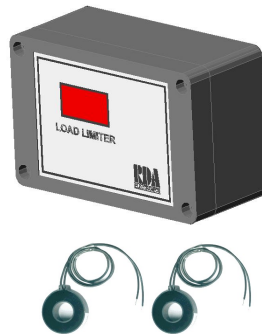

Principle of Operation

Since the torque of a squirrel cage motor is directly proportional to the current draw of the motor, RDA has designed a microcomputer that monitors the electrical current drawn by a motor. The LL200 can simulate the amount of load which is lifted by a motor according to the electrical current drawn by the motor.

A hoist motor is designed to lift a safe working load (SWL). Based on the horsepower required and the power supply a nominal motor current is established for the safe working load.

In the event that hoist motor attempts to lift a load greater than the safe working load a higher motor current will be detected and the limit device will be activated. Then limiter will not be allow the load to be lifted until the overload condition has been removed.

Parameters:

With the LL200 load limiter you can adjust following parameters:

Motor Start Time: (0.1 Sec to 25 Sec), this is the time for starting the motor; during this time load limiter ignores the starting inrush current.

Overload time: (0.1 Sec to 25 Sec), after starting if the current remains high past this time it will activate the output relay.

Reset time: (0.1 Sec to 25 Sec), after overload the relay will reset when this time pass.



High Speed Current: (1 A to 100 A), nominal current setting for high speed.

Low Speed Current: (1 A to 100 A), nominal current setting for low speed.



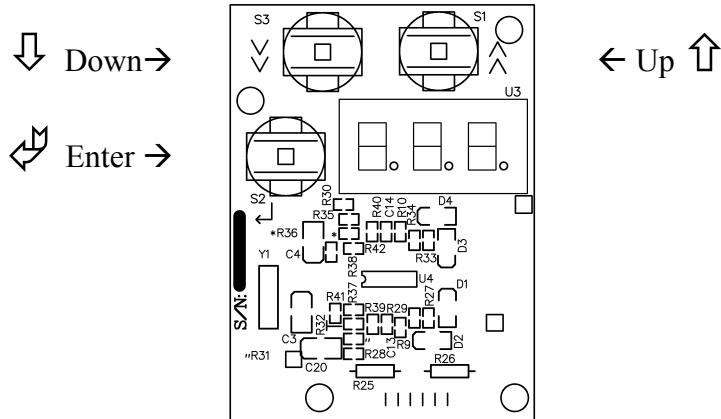

Adjusting the parameters:

When you open the cover the device has 3 pushbuttons as follows:



For setting the parameters the enter button  should be pressed and held for approx 5 seconds until the display shows start “**StA**” by pressing either the up button  or the down button  you can select the parameter that you wish to set. The display will show as follows:

StA	Start time
OL	Overload time
RES	Reset time
-HI	High Speed Current
_LO	Low Speed Current

After selecting the desired parameter, by pressing the enter button  the value of that parameter will appear on the display. By pressing the up button  and down button  you can adjust the value. In order to save the parameter setting you must press the enter button  again. If the process is okay, the display will show saved “**SAU**” for a few seconds before returning back to normal operation. In normal operation the display will show the motor current in Amps.

Specifications:

Power Supply:

Rated value	110V or 220V (-15%, + 20%)
Frequency	45 to 65 Hz
Burden	5 VA

Display:

Range	0 ... 999
Type	LED ,7 segments, 3 digits
Color	Red
Data updating time	1 Sec

Input circuit:

A/D Converter resolution DC	10 bits (1024 points conv.)
Conversion method	Successive approximations
Conversion time	600 μ S
Measurement accuracy	0.15 % \pm 1 digit
Measurement range	1.3 rated value
Overload	2 In continuously
Burden	0.055 VA

Output relay:

Rated AC current	6 A
Max AC current	10 A
Rated voltage	250 VAC, 50/60 Hz
Insulation resistance	>100 M Ω @ 500VDC
Mechanical life	10 million operations
Electrical life	100,000 operations

Current transformer (CT):

Primary current	100 A
Secondary current	50 mA
Accuracy	1 %
Applied voltage test	1000 V
Insulation resistance	100 M Ω
Dimension (mm)	Toroid 15.3 (ID), 34.7 (OD), 13.2 (H)
Weight	30 g

Enclosure:

Material	ABS
Color	Dark gray
Protection	IP 65
Dimension (mm)	120 x 80 x 55
Weight (w/o cable)	0.5 Kg

Environment:

Storage temperature	-40 to 70°C
Operation temperature	-20 to 60°C
Humidity	<70 % R.H.

Wiring Diagram:

WIRING DIAGRAM

